

Eisenhammer

CAD/CAM TRAINING PROGRAM

**GET STARTED
NOW**



2025 / 26



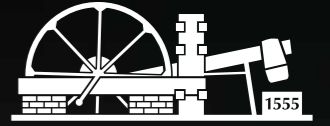

LET'S GET US STARTED TOGETHER!

We are pleased to present our EISENHAMMER course program to you. A program that is characterized by the innovative spirit of our employees and the experience of many years of partnerships with pioneering speakers, as well as building on the tradition of the stately EISENHAMMER.

Since 1555 the EISENHAMMER in Lippoldsberg has stood for progress and is a signpost for new production techniques. For many centuries, investments have been made in the advancement of technological innovations. After each expansion of the production facilities, the workers were conscientiously retrained and trained. In its heyday, the EISENHAMMER had 8 water wheels to drive its bellows and hammers and was given melting, embossing and burning rights by the Elector, which are still valid today.

New technologies have also opened up a new era in dental technology and dentistry. The sequence of new developments in the dental CAD/CAM world is getting faster and faster. Regular training of the teams on the systems has never been as important as it is today. We are at your side with the highest level of know-how, state-of-the-art technologies and a comprehensive course program. It doesn't matter whether you're starting out from scratch or simply want to pick up more speed, we'll provide you with professional support.

Use the CAD/CAM course program of Dental Concept Systems at the EISENHAMMER and follow a centuries-old tradition of innovation and advancement of technology in a firm harmony of education and training for users.



Hartmut Reins
CEO / Managing Director
Dental Concept Systems GmbH



KCOURSE OVERVIEW

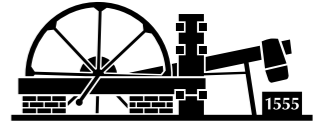

VIP - CAD/CAM EVENT

Your exclusive invitation to the Wesertal!

06

Eisenhammer *Premium* COURSES

07 - 27

OUR SPEAKERS ... introduce themselves!	08
conceptCAD™ Implant course - Successful construction!	12
conceptCAD™ Model casting course	13
FULL METAL TELESKOP ... the special telescope course!	14
FULL METAL BAR ... the special bar course!	16
GO HIGHER... ... calculated, invested, consistently to success!	18
... DIGITAL - WHAT ELSE? the digital immediate concept	20
DENTAL AESTHETICS IN CHANGE OVER TIME - Backward planning finally taken seriously	22
MODERN ART Introduction to the visio.lign system	24
MAKE IT YOUR OWN MONOLITHIC WAY Form, surface and aesthetics, color and "depth" only painted	26

studio55 *Premium* COURSES

28 - 34

DENTAL PHOTOGRAPHY WITH CONCEPT Course for dental product photography	30
DENTAL PATIENT PHOTOGRAPHY A practical workshop	32

BASIC COURSES

35 - 38

CAM BASICS FOR DCQ™ / DCX™ / DC1™	36
CAM BASICS FOR DC3V™ / DC7™	37

ADVANCED COURSES

39 - 42

THE WAY TO A PERFECT SUPERSTRUCTURE WITH CONCEPTCAD™ AND THE DCS SYSTEM	40
DIGITAL SECONDARY STRUCTURES	41
MANUFACTURING TELESCOPIC CROWNS WITH THE DCS SYSTEM	42

conceptCAD™ COURSES

43 - 46

conceptCAD™ BASIC-TRAINING	44
conceptCAD™ ADVANCED-TRAINING	45

expertCAM™ COURSES

47 - 50

expertCAM™ BASIC-TRAINING	48
expertCAM™ ADVANCED-TRAINING	49

conceptCAM™ COURSES

51 - 54

conceptCAM™ BASIC-TRAINING	52
conceptCAM™ ADVANCED-TRAINING	53
conceptCAM™ IMPLANT-TRAINING	54

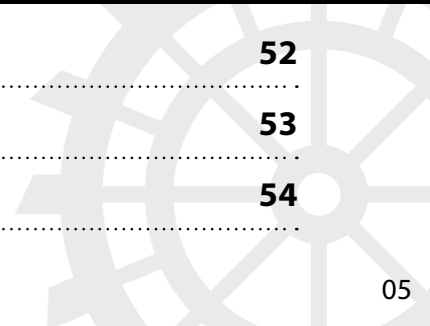

VIP - CAD/CAM EVENT

Your exclusive invitation to the Wesertal!

When you visit this exclusive CAD/CAM event, you will be given a look behind the scenes.

A very special company presentation provides a wide range of information about the DCS device family.

An exciting program is offered, from development to production to the completion of all system components.

Digital technologies, presented live at the Dental Concept Systems production site, offer an overview of the current state of the art for the dental user.

Event content

- Introduction to the company and company tour
- Tour of production
- Machine design and components
- CS support structure
- Scanner + CAD
 - What needs to be considered!
- Designing for production
- Materials and tools
- Live milling demonstration in CoCr

Target group

Users and those interested in the DCS device family

Event details

Course duration: **1 day**

11:00 a.m. to 3:00 p.m.

Course fee*: **€ 160,00 per participant**

If you subsequently book a DCS course, the event is free of charge for you!

* The course fee stated does not include overnight accommodation costs. These costs must be borne by the respective course participant. We will be happy to help you choose suitable accommodation.

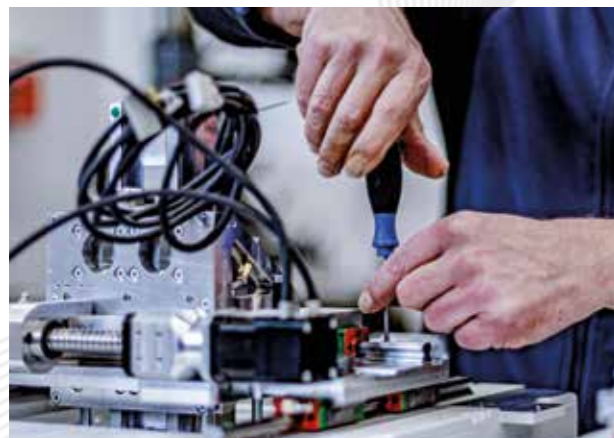

Premium
COURSES



OURS **SPEAKERS**

... introduce themselves!

In addition to fascinating technologies, we are at your side with a special selection of speakers from all specialist areas. In order to be able to operate extensive technologies and systems successfully, a constant thirst for knowledge must be satisfied with the highest level of know-how in order to always be able to achieve maximum success. This is exactly where our team of speakers is the right partner for you. Come on board at our Eisenhammer training center in the Wesertal.



Lars Schäfer
Master dental technician

LARS **SCHÄFER**

- Dental technician since 1990
- 2000 Master dental technician examination
- 2004 Founding of AXIO DENT®
- 2005 First milling system
- 2013 First DCS milling system
- Specialization in milling technology and CAD/CAM technology
- Speaker at the SH master school for milling courses
- Speaker at EISENHAMMER Full Metal Telescope
- Development supervisor at DCS since 2015
- Decider/Evaluator hyperDENT®



Tim Übermuth
Dr. med. dent. / M.Sc.

TIM **ÜBERMUTH**

- 1999 Doctorate in dentistry at the Albert Ludwigs University, Freiburg
- (3-D CT examination of the pig jaw)
- 2004 Focus on implantology (BDIZ, DGI)
- since 2008 speaker & trainer "guided implant surgery"
- 2011 "Master of Science in Oral Implantology" (DGI)
- 2011 Grant of patent DE 10 2008 058 305 B4 for a new implant-prosthetic concept
- 2014 Head of "DGI Quality Circle Celle"
- 2017 "Master of Science in Oral Implantology and Periodontology" (DGI)
- 2020 Academic teaching practice at DTMD University, Luxembourg
- 2021 Trainer Implantology (IFZI Training Institute, Nuremberg)
- 2021 Head of "iCAD Training Institute, Celle"
- 2021 German Innovation Award for RevoCone®
- 2024 Clinical Director and Course Leader IFZI (Clinical chief supervisor)



Tim-Lennart Wittig
Master dental technician

TIM-LENNART **WITTIG**

- 2002-2005 training - Zahntechnik Schmidt in Plüderhausen
- 2005-2010 employed as a dental technician at Zahntechnik Schmidt in Plüderhausen
- 2010 master craftsman's examination in Stuttgart, self-taught - youngest external master craftsman
- 2010-2013 employed master dental technician and laboratory manager at Waiblinger Dentallabor GmbH
- 2013 - Managing partner at Waiblinger Dentallabor GmbH
- Further training with various colleagues, including Jürg Stuck, Axel Seeger, Haristos Girinis, Björn Maier, Andrea Foschi



Axel Seeger
Master dental technician

AXEL **SEEGER**

- 1985 journeyman's examination
- 1987 work stay in Paris
- 1991 and 1992 years of traveling as a dental technician in: New Zealand, Australia, Hawaii, California
- Since 1994 courses and lectures worldwide (e.g. in the USA, Korea, Taiwan, China, South Africa and most European countries)
- 1995 master's examination
- Since 1997 own laboratory for fixed dentures in Berlin
- 2011 publication of the specialist book Smile
- Since 2017 own course concept for the „monolithic painting technique“ aesthetics implemented economically
- 2017 publication of the specialist book Make it your own monolithic way
- 2023 publication of the specialist book Monolithic workbook

Premium
KURSE

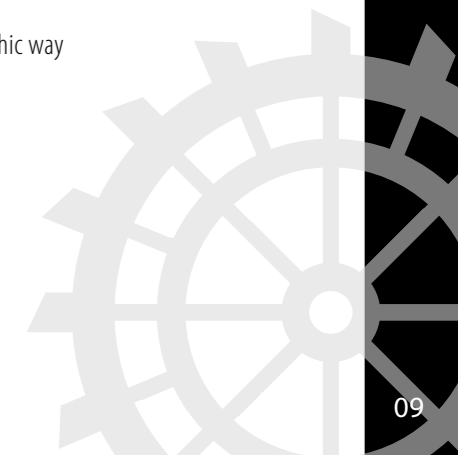

OURS **SPEAKERS**

... introduce themselves!



Bertram Bacher
Master dental technician

BERTRAM **BACHER**

- 2001 - 2007 Dual-subject Bachelor's degree in Chemistry & Physics, University of Osnabrück
- 2013 - 2017 Training as a dental technician, „Neue Zähne“, Osnabrück
- 2017 Dental technician model casting, „Neue Zähne“, Osnabrück
- 2017- 2019 Dental technician, Volkmer dental laboratory, Rheine
- 2019 - 2020 Advanced training as a master dental technician, Münster Chamber of Crafts
- 2020 - 2021 Master dental technician, Dr. Tim Rybacki's practice laboratory, Reckenfeld
- 2021 - 2022 Junior Sales Manager, Amann Girrbach GmbH, Pforzheim
- 2022 - 2023 Master dental technician, Wifodent GmbH, Münster
- 2023 - present Employee of the bredent® group



Joachim Werner
PHOTOGRAPHY

JOACHIM **WERNER**

- 1983 - 1986 Training as a dental technician
- 1986 - 1987 Model casting technician at the Graatz dental laboratory / Duisburg
- 1987 - 1988 Bundeswehr dental station in Bremen
- 1988 - 1989 Precious metal technician at the Graatz dental laboratory / Duisburg
- 1989 - 1994 Precious metal technician at the Glaubert dental laboratory / Witten
- 1994 - 1995 Master school / Düsseldorf
- 1995 - 2018 Self-employed master dental technician Essen
- 2016 - 2019 Development and direct sales of JoStage® photo table / Essen
- 2011 - today Self-employed photographer



Ivana Pasalic
dental technician

IVANA **PASALIC**

- Dental technician since 1999
- 1999 - 2011 Employed dental technician
- 2011 - 2017 Laboratory manager
- 2017 - 2022 Employed dental technician
- 2023 Founding of Holistic Smile Design GmbH



Frank Köpp
Master dental technician - M. Sc.

FRANK **KÖPP**

- Dental technician since 2021
- 2001 - 2006 Employed dental technician
- 2006 - 2012 Self-employed dental technician
- 2008 Master's examination (external)
- 2012 - 2014 Employed Master dental technician
- 2014 - 2020 Medical device consultant and system consultant at Bredent
- 2018 - 2022 M.Sc. for digital dental technology at the University of Greifswald
- 2020 - 2023 Training manager and 2nd-level support at Dental Concept Systems
- 2023 Founding of Holistic Smile Design GmbH

Premium
COURSES



conceptCAD™

Implant course - Successful construction!

This implant course offers a valuable opportunity for dentists and dental technicians to expand their skills in digital implant planning and design. By focusing on implementation in conceptCAD™ and the technical challenges of milling, participants will be optimally prepared to offer high-quality implant solutions in their practice upon completion of the course.



Bertram Bacher
Master dental technician

conceptCAD™

Model casting course

The course on the production of a cast model prosthesis offers participants comprehensive training in the digital design and practical implementation of telescopes and other prosthetic technologies. Thanks to the practical exercises, participants are able to independently design high-quality cast model prostheses and successfully implement them in their laboratory after completing the course.

In this practice-oriented course, participants learn how to create a cast model prosthesis with particular attention to the design of telescopes, RSS attachments and clasps. The training provides comprehensive knowledge of the software application used and emphasizes the technical details that are crucial in the production of the prosthesis.

Course content

Selecting the right scanbody

- Introduction to the different types and their specific applications

Construction of occlusally screwed crowns

- Detailed training on digital construction in conceptCAD™

Individual abutments with superstructure

- Construction of individual abutments

Implant-supported primary telescopes

- Introduction to planning and construction

Primary bars with 2 abutments

- Demonstration, construction and instructions for minimizing errors

Use of 2 RevoCone™ as abutment extension

- Practical tips on construction

Target group

Qualified dental technicians and experienced exocad™ / conceptCAD™ users

Course details

Course duration: **1 day**
9:00 am to 6:00 pm
Course fee: **€ 580.00 per participant**
(max. 6 participants / incl. material costs)

* The course fee stated does not include overnight accommodation costs. These costs must be borne by the respective course participant. We will be happy to help you choose suitable accommodation.

Course content

Data export and meshing

- Instructions for data collection and export, techniques for measuring and editing digital models

Creation of secondary telescopes

- Instructions for creating secondary telescopes

Creation of an RSS attachment

- Demonstration of the design and integration of an RSS attachment

Creation of a model casting

- Instructions for creating a model casting prosthesis with different holding and connecting elements

Creation of an interim prosthesis:

- Instructions for quickly creating an interim prosthesis

Target group

Qualified dental technicians and experienced exocad™ / conceptCAD™ users

Course details

Course duration: **1 day**
9:00 am to 6:00 pm
Course fee: **€ 580.00 per participant**
(max. 6 participants / incl. material costs)

* The course fee stated does not include overnight accommodation costs. These costs must be borne by the respective course participant. We will be happy to help you choose suitable accommodation.

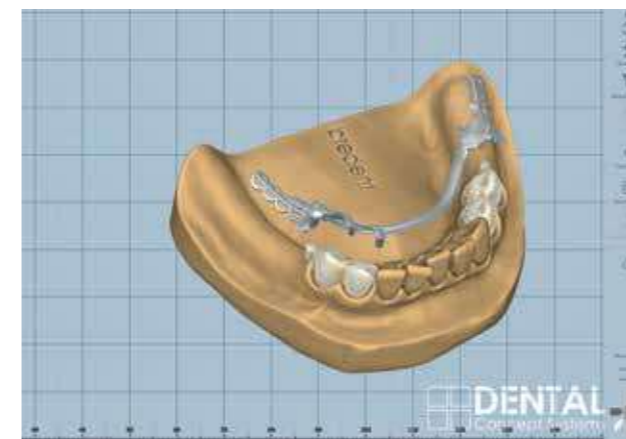
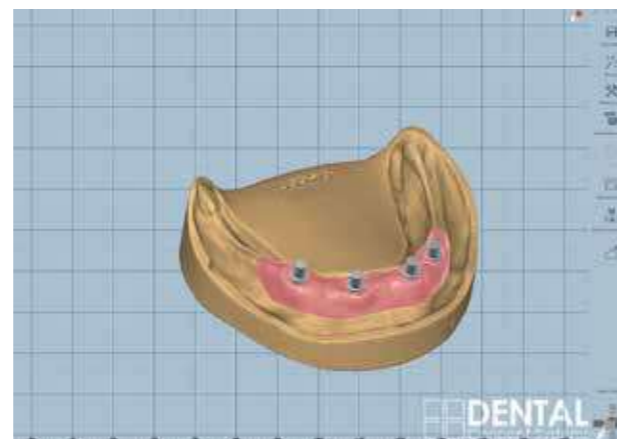

FULL METAL TELESKOP

... the special telescope course!

The special telescope course for users of DCS systems who want to optimize and specify their workflow.

From the experienced DCS user for users with a system.

Step by step to successful telescope production - from the individual telescope to the circular supply for all members of the DCS device family.



Lars Schäfer
Master dental technician



Course content

- Planning and preparation of primary and secondary care
- Manual remilling of the primary parts
- Optical telescope scanning in the Eagle Eye™
- Milling secondary telescopes on the various DCS systems
- Workflow in the CAM systems conceptCAM™ and expertCAM™
- Fundamentals of machining technology and HSC machining
- Tool knowledge and machining parameters
- Identifying problems and adjusting the parameters in the machine and CAM
- Dealing with digital data maintenance
- Optimization of controllable

Target group

DCS users who want to go into depth when manufacturing telescopes in order to optimize the processes.

Course details

Course duration: **2 days**

Day 1: 9:00 a.m. to 5:00 p.m.

Day 2: 9:00 a.m. to 3:00 p.m.

Course fee*: **€ 1.500,00 per participant**
(max. 6 participants / incl. material costs)

* The course fee stated does not include overnight accommodation costs. These costs must be borne by the respective course participant. We will be happy to help you choose suitable accommodation.



Eisenhammer

FULL METAL BAR

... the special bar course!

A course for DCS users who want to safely produce bridge work with secondary structures and learn the necessary background knowledge in practice. The production of superstructures is often a challenge and is therefore taught in this course in a way that is just as understandable and user-friendly as, for example, in Lars Schäfer's course for telescopes.



Lars Schäfer
Master dental technician



Course content

- Designing bars and attachments
- Digital backward planning
- Designing secondary bars
- Useful tools in conceptCAD™
- Options for attaching construction elements
- Scanning bars
- Scanning options
 - Advantages and disadvantages of the processes
- Tips and tricks from everyday life
- Practical application of the milling process for bars
- The optimal preparation of the work
- Materials for manufacturing
- Tool theory

Target group

DCS users who want to go into depth when making bars in order to optimize the processes.

Course details

Course duration: **2 days**
Day 1: 9:00 a.m. to 5:00 p.m.
Day 2: 9:00 a.m. to 3:00 p.m.
Course fee*: **€ 1.500,00 per participant**
(max. 6 participants / incl. material costs)

* The course fee stated does not include overnight accommodation costs. These costs must be borne by the respective course participant. We will be happy to help you choose suitable accommodation.



Eisenhammer

GO HIGHER...

... calculated, invested, consistently to success!

This course is a guide for dental entrepreneurs to make a calculated decision in favor of the permanently worthwhile digital path.

The presentation of simple principles, based on many years of experience, shows clear handling for complex decisions, before and during the use of digital systems.



Lars Schäfer
Master dental technician

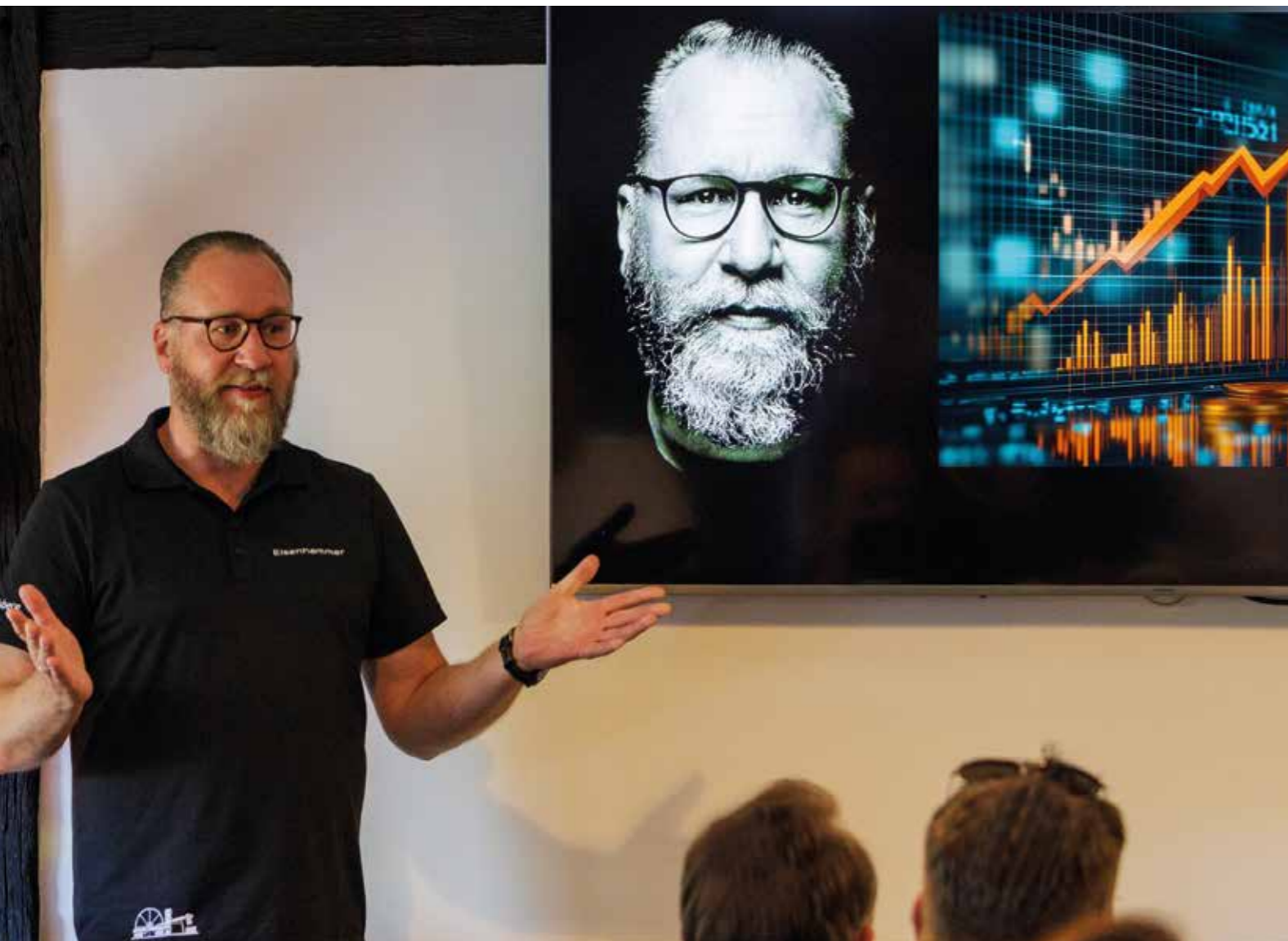

Course content

Milling machine X, Y or Z or better a system from A to Z?

- The right choice of a milling system
- Step by step to your own milling machine
- Which criteria are actually decisive?
- Carelessly overlooking hidden costs

How do i write my own CAD/CAM success story?

- Economic calculation explained plausibly
- Practical workshop on real time management
- Hourly rate and material usage rate
- With a rule of thumb to success

An open system!

Closed voluntarily by the user!

- The correct purchase of all components
- Honest assessment of one's own competence
- One wrong turn...
- Fixed principles in the digital workflow

Dental technical experience in the digital dental world

- Lars Schäfer – a digital review
- From dental technician to CAD/CAM specialist
- Where is the right place to start cutting costs?
- Which decisions were decisive?

Target group

Dental entrepreneurs and managers interested in digital guidance from a business perspective.

Course details

Course duration: **1 day**
4:00 pm to 7:30 pm
mit anschließendem Abendessen
Course fee*: **€ 360,00 per participant**
(max. 15 participants)

* The course fee stated does not include overnight accommodation costs. These costs must be borne by the respective course participant. We will be happy to help you choose suitable accommodation.



DCS course package!

FULL METAL BAR
+ GO HIGHER...
€ 1.650,00
per participant!

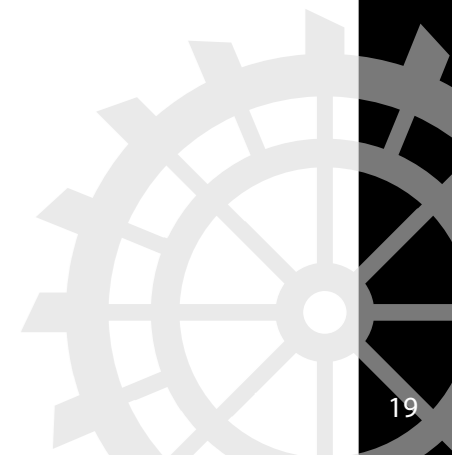

... DIGITAL - WHAT ELSE?

the digital immediate concept

From handling data sets and backward planning to selecting the right implants in the Fast & Fixed protocol.

In this course offer you will learn how to put the digital workflow into practice use and implement it in your everyday life.



Tim Übermuth
Dr. med. dent. / M.Sc.



Course content

Day 1 (theoretical part):

- Implant planning with CoDiagnostiX
- Handling of records
- The right choice of implant
- Indication immediate implantation vs. immediate loading
- Virtual insertion and risk assessment
- Prosthetically oriented planning - „backward planning“
- When is the right time for augmentation?
- Fast & Fixed in the digital workflow (1)

Day 2 (practical part):

- Design of immediate provisionals
- Fabrication of milled temporaries
- Fast & Fixed im digitalen Workflow (2)
- RevoCone® - the lifetime abutment

Target group

Dentists, gladly with their dental team.

Course details

Course duration: **2 days**

Day 1: 9:00 a.m. to 4:30 p.m.

Day 2: 9:00 a.m. to 3:30 p.m.

Course fee*: **€ 1.750,00 per participant**

(max. 8 participants / incl. material costs)

*The course fee stated does not include overnight accommodation costs. These costs must be borne by the respective course participant. We will be happy to help you choose suitable accommodation.

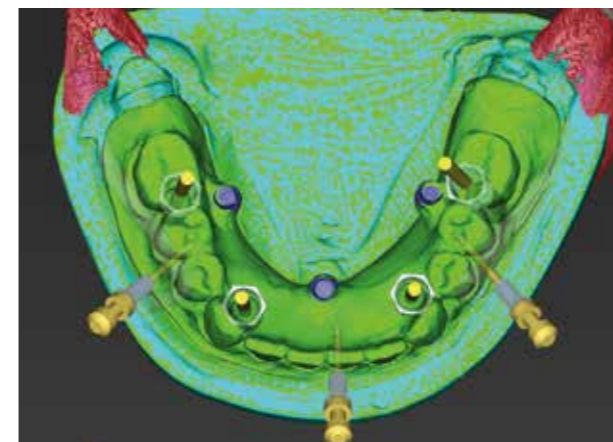

DENTAL AESTHETICS IN CHANGE OVER TIME

Backward-planning
finally taken seriously

This course will show you how to create complex restorations with the help of AI-supported applications.

In this case, real backward planning means that the patient is analyzed and aesthetically modified based on the previously created photo status in the Smilecloud. This data is imported into Exocad® and adjusted in the 3D environment. The possibilities and advantages of combining 3D printing and milling are then explained and illustrated.

The frameworks are then manufactured and completed.

The course concludes with a 3D printing excursion.



Ivana Pasalic
Dental technician



Frank Köpp
Master dental technician - M. Sc.



Course content

- Instructions on how to create complex restorations using AI-supported applications.
- Explanation of real backward planning, i.e. the patient is analyzed and aesthetically modified based on the previously created photo status in the Smilecloud.
- Importing the data obtained into exocad® and adjusting it in the 3D environment
- Explanation of the possibilities and advantages of combining 3D printing and milling
- Manufacturing and completion of the frameworks
- Including a final 3D printing excursion

Target group

Qualified dental technicians,
as well as experienced CAD/CAM users

Course details

Course duration: **2 days**

Day 1: 9:00 a.m. to 4:30 p.m.

Day 2: 9:00 a.m. to 4:30 p.m.

Course fee*: **€ 1.500,00 per participant**
(max. 6 participants / incl. material costs)

*The course fee stated does not include overnight accommodation costs. These costs must be borne by the respective course participant. We will be happy to help you choose suitable accommodation.

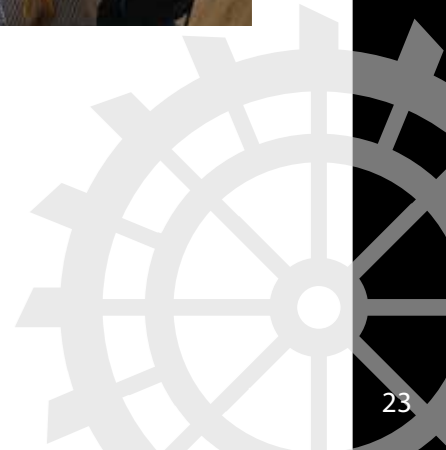

MODERN ART

Introduction to the visio.lign system

In this two-day course with theory and a lot of practice, you will be introduced to the safe use of the visio.lign system.

On two quadrants of a 14-unit HIPC bridge, the course participants will be introduced to painting and layering techniques.

Afterwards, a brief insight into red and white aesthetics will be given.



Tim-Lennart Wittig
Master dental technician



Course content

- General theoretical introduction to the visio.lign aesthetic and functional system
- Painting and individualization of a quadrant with visio.lign color and visio.lign shield on a 14-unit HIPC bridge
- Creation of a cut-back and internal painting of another quadrant on a 14-unit HIPC bridge
- Layering and overpressing this quadrant with the new crea.lign opaque dentines and HT materials
- Brief insight into red-white aesthetics

Target group

Apprentices from 3 years of training, young technicians and master craftsmen, laboratory managers.

Course details

Course duration: **2 days**

Day 1: 9:00 a.m. to 6:00 p.m.

Day 2: 9:00 a.m. to 4:00 p.m.

Course fee*: **€ 949,00 per participant**

(max. 8 participants / incl. 1x hotel overnight stay, meals and evening event)

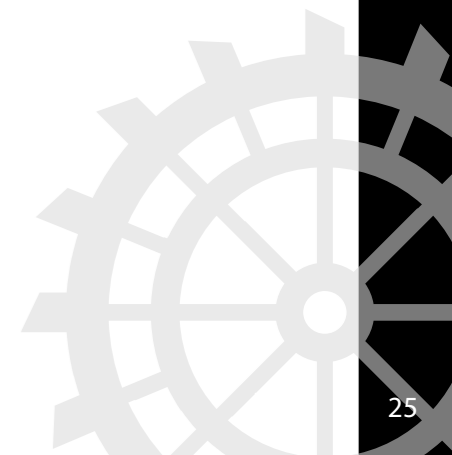

MAKE IT YOUR OWN MONOLITHIC WAY

Form, surface and aesthetics,
color and "depth" only painted

The one-day intensive course teaches participants in theory and practice the surface design and painting technique using four front teeth (two young, two older front teeth and one molar).



Axel Seeger
Master dental technician

Monolithic workbook

Form Shape | Oberfläche Surface | Ästhetik Aesthetics | Rentabilität Profitability



Course content

- Powerpoint presentation with many patient cases
- Cost-effectiveness
- Age-specific preparation of crowns using the example of 2 young and older front teeth and one side tooth
- Painting technique implemented aesthetically and age-specifically
- The right glaze mass
- Individual firing
- Aesthetics implemented economically

Target group

Apprentices from 3 years of training, young technicians and master craftsmen, laboratory managers.

Course details

Course duration: **1 day**
9:00 am to 5:00 pm
Course fee*: **€ 695,00 per participant**
(max. 6 participants - including display model, 5 milled and sintered zirconium crowns)

* The course fee stated does not include overnight accommodation costs. These costs must be borne by the respective course participant. We will be happy to help you choose suitable accommodation.



Note:

This is an external premium course, which takes place under the speaker's own direction in the premises of the Eisenhammer training center.

Please register at:

www.axelseeger.com or email: seegerart101@gmail.com



WILLKOMMEN!

With Studio55, Dental Concept Systems has created a place where aesthetic imagery for dental technology is to be developed and important building blocks for successful marketing in practices and laboratories are created and trained.

For the virtual representation of our partners, but also for us as industry partners, the demand for a professional appearance of our fields of activity cannot be high enough.



studio55

Jon Jerner
PHOTOGRAPHY

DENTAL PHOTOGRAPHY WITH CONCEPT

Course for dental product photography

Let us immerse ourselves in the wonderful world of dental product photography in this one-day course. Your work deserves to shine in the best possible light. In hardly any other profession is it simultaneously so important and yet so difficult to photograph different materials and surfaces realistically and objectively, and thus to present, promote and highlight certain properties.

In this course I will show you how to design dental products, adjust the lighting and put together different exposure options.



Joachim Werner
PHOTOGRAPHY

Course content

- Interactive lecture
- Camera technology
- Lighting technology (the same light sources are used here as in patient photography)
- Substrate, background and bouncer
- The Dome
- JoStage®
- Image composition and image psychology
- Object photography against light and dark backgrounds
- Introduction to professional product photography
- Personalization
- Introduction to image editing
- Image management

Target group

Dental technicians, dentists, orthodontists, dental assistants and specialist staff.

Course details

Course duration: **1 day**

9:00 am to 6:00 pm

Course fee*: **€ 860,00 per participant**

(max. 6 participants)

What you should bring with you:

- Photo equipment including flash and camera operating instructions (if available)
- CompactFlash SD memory card (at least 16 GB)
- Models for taking photos
- Memory stick (8GB)

* The course fee stated does not include overnight accommodation costs. These costs must be borne by the respective course participant. We will be happy to help you choose suitable accommodation.



DENTAL PATIENT PHOTOGRAPHY

A practical workshop

In this one-day course, you will learn the photographic basics of dental patient photography through exciting and practical exercises. Each participant photographs a complete patient status and thus learns how to master the special challenges of patient photography. In addition, course participants will receive helpful tips and tricks from dental photography practice.

In a personal preliminary discussion, we will talk about your expectations regarding the course and what camera and equipment you have. This way, I am optimally prepared for each course participant.

Of course, you can take pictures during the course, for example of the settings of the flash unit or the setup, so that the content is always tangible and present after the course.

In the course itself, you will learn how to assess the brightness of the image using the luminance histogram and regulate it using just two settings. Angle, image section and image sharpness, always taking the correct exposure and lighting into account, are also important course content. Two lenses, different flash units and light shapers are used here.

I will also explain and demonstrate the advantages of the polarizing filter when determining tooth color. The interaction of ISO, aperture and time with a selected light source will also be clear to you.

The aim of the course is to make dental patient photography a rational part of your daily work in the practice. Ideally, the images taken do not require any further processing and can be used directly.

The only requirement for taking consistently good pictures in the future is: You have to have fun doing it. I'll show you everything else.



Joachim Werner
PHOTOGRAPHY

Course content

- Interactive lecture
- Camera settings
- Lenses (50 mm and 100 mm macro)
- Flash technology (lateral flash, ring flash and softboxes)
- Dental portrait (against light and dark background)
- Mouth shots (extra and intraoral, mouth mirror shots)
- Equipment for mouth photography: (Different cheek retractors, contrastors and mouth mirrors)
- Dental photo status
- Photos in the dentist's office
- My photo studio in the laboratory
- Emotional photos
- My photo case
- Concept for image management
- Introduction to image processing and image presentation

Target group

Zahntechniker, Zahnärzte, Kieferorthopäden, Zahnarzhelfer*innen und Fachpersonal.

Course details

Course duration: **1 day**
9:00 am to 6:00 pm
Course fee: **€ 860,00 per participant**
(max. 6 participants)

What you should bring with you:

- Photo equipment including flash and camera operating instructions (if available)
- CompactFlash SD memory card (at least 16 GB)
- Models for taking photos
- Memory stick (8GB)

* The course fee stated does not include overnight accommodation costs. These costs must be borne by the respective course participant. We will be happy to help you choose suitable accommodation.



**Combine the courses
DENTAL PHOTOGRAPHY
WITH CONCEPT
and
DENTAL PATIENT PHOTOGRAPHY
and enjoy the benefits!**



studio55

IMPRESSIONS

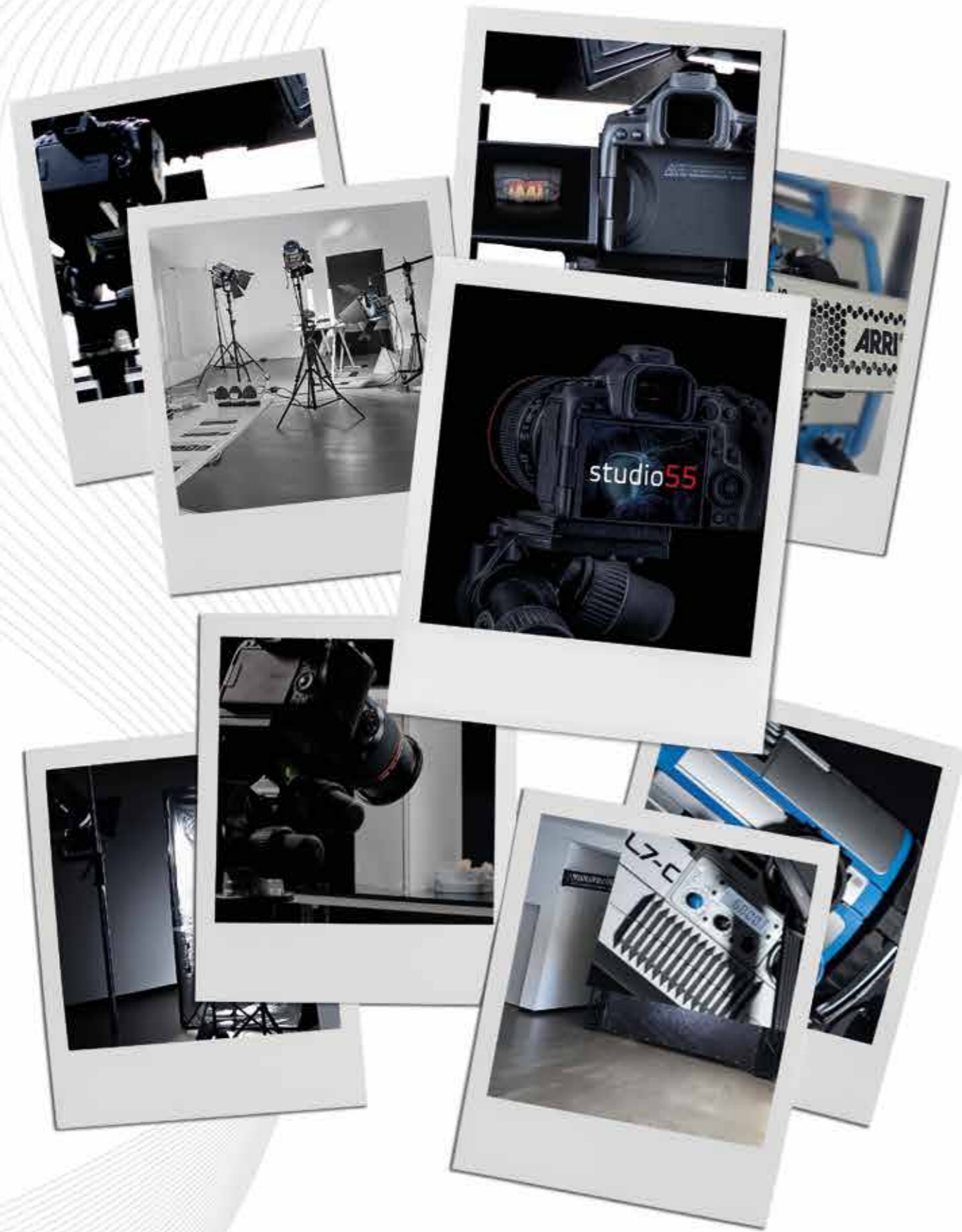

BASIC COURSES



CAM Basics for DCQ™ / DCX™ / DC1™

A must for all owners of a DCQ™ / DCX™ / DC1™ milling system.

This workshop will provide you with the complete knowledge for the safe and successful use of the DCQ™ / DCX™ / DC1™ milling system.

Our instructors will explain the structure and the functional principle of the system in theory and practice. In addition to an introductory theoretical part, in which the structure and the functional principle as well as the installation of the DCQ™ / DCX™ / DC1™ milling system are explained, you will learn to mill the most diverse materials with the DCQ™ / DCX™ / DC1™ system on the basis of specific examples.

Course content

- Structure and functional principle of the DCQ™ / DCX™ / DC1™ milling system
- Installation and integration into the laboratory network
- Introduction to the CAM software
- Explanation of important CAD parameters
- Practical examples - scanning, designing, CAM preparation, milling with various materials
- Maintenance and troubleshooting

Target group

Users and interested parties of the DCQ™ / DCX™ / DC1™ milling system

Course details

Course duration: **1 day**
10:00 am to 6:00 pm
Course fee*: **€ 550,00 per participant**
(max. 8 participants / incl. material costs)

* The course fee stated does not include overnight accommodation costs. These costs must be borne by the respective course participant. We will be happy to help you choose suitable accommodation.



CAM Basics für DC3™ / DC7™

A course for those interested in the DC3™ / DC7™ milling systems. In this workshop the knowledge required for the safe and successful use of the DC3™ / DC7™ milling systems will be presented along with demonstrations of new uses for current technologies. Our instructors will explain the structure and the functional principle of the system in theory and practice. In addition to an introductory theoretical portion, in which the structure and the functional principle as well as the installation of the DC3™ / DC7™ milling systems are explained, you will learn to mill the most diverse materials with the DC3™ / DC7™ systems with specific examples.

We will explore the additional options of the DC3™ / DC7™ milling systems such as automation.

Course content

- Structure and functional principle of the DC3™ / DC7™ milling system
- Installation and integration into the laboratory network
- Introduction to the CAM software
- Explanation of important CAD parameters
- Practical examples – scanning, designing, CAM preparation, milling with various materials
- Milling with automation
- Maintenance and troubleshooting

Target group

Users and interested parties of the DC3™ / DC7™ milling system

Course details

Course duration: **1 day**
10:00 am to 6:00 pm
Course fee*: **550,00 € per participant**
(max. 8 participants / incl. material costs)

* The course fee stated does not include overnight accommodation costs. These costs must be borne by the respective course participant. We will be happy to help you choose suitable accommodation.



DCS MILLING SYSTEMS

START A FAMILY BUSINESS

Systems from Dental Concept Systems enable dental laboratories all over the world to offer a wide range of options through intelligent combination. Device family systems can be controlled and control software. These are benefits that many users have recognised and successfully put to good use in modern dental laboratories.

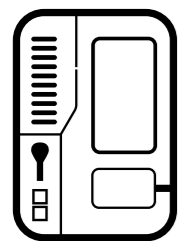

DCQ™

clever

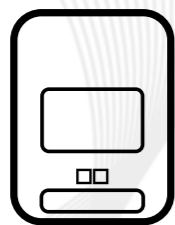

DCX™

smart

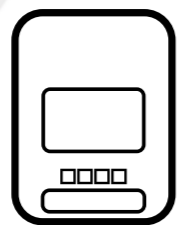

DC1™
—PRO—

compact

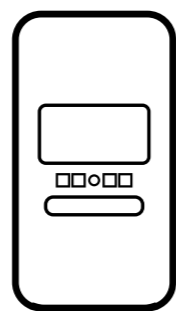

DC3™
—PRO—

individual

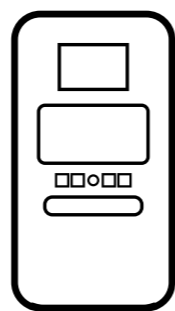

DC7™
—PRO—

maximum

ADVANCED COURSES



The way to a perfect superstructure with conceptCAD™ and the DCS system

Digital secondary structures

Course content

- construction of Primary telescopes and abutments
- Constructing secondary constructions
- The way through the expert mode
- Opportunities related with model casting
- Inclusion of construction elements
- Telescope scanning
- Possibilities of the scan - Advantages and disadvantages of the procedures
- Tips and tricks from everyday life
- The optimal preparation of the work
- Useful tools in conceptCAD™
- Materials for manufacturing

Target group

Beginners in conceptCAM™ and expertCAM™ as well as CAD/CAM beginners

Requirements

Dental technicians with CAD/CAM experience in DCS systems

Course details

Course duration: **1 day**
 8:00 am to 6:00 pm
 Course fee*: **€ 685,00 per participant**
 (max. 8 participants)

*The course fee stated does not include overnight accommodation costs. These costs must be borne by the respective course participant. We will be happy to help you choose suitable accommodation.



Course content

- Constructions of Implant bars, attachments and bridges
- Digital backward planning
- Constructing secondary bridges
- Possibilities for attaching structural elements
- Scanning bars
- Scanning optimization – benefits and disadvantages of the procedure
- Tips and tricks for the daily grind
- Optimal work preparation
- Helpful Tools in conceptCAD™
- Materials for manufacturing

Target group

Beginners in conceptCAM™ and expertCAM™ as well as CAD/CAM beginners

Requirements

Dental technicians with CAD/CAM experience in DCS systems

Course details

Course duration: **1 day**
 8:00 am to 6:00 pm
 Course fee*: **€ 850,00 per participant**
 (max. 6 participants)

*The course fee stated does not include overnight accommodation costs. These costs must be borne by the respective course participant. We will be happy to help you choose suitable accommodation.



Manufacturing telescopic crowns with the DCS system

Course content

- Production of frictive secondary telescopes in the DCS workflow
- Selection of the right scanning option
 - tactile or optical scan
- Determination of the possibilities for bar, cone or telescope work
- Design with the conceptCAD™ for different DCS systems
- Definition of all variables that influence to have a perfect fit
- Telescope workflow in the CAM systems conceptCAM™ and expertCAM™
- Tool knowledge and machining parameters
- Identify problems and adjust parameters in machine and CAM
- Self-constructed restoration for each course participant
- Practice-oriented introduction for independent implementation on your own milling system

Target group

Dental technicians who want to gain more CAD/CAM experience for their DCS systems

Requirements

Users in conceptCAM™ or expertCAM™ with solid basic digital knowledge

Course details

Course duration: **2 days**
1st day: 9:00 a.m. to 5:00 p.m.
2nd day: 9:00 a.m. to 4:00 p.m.
Course fee*: **€ 1.500,00 per participant**
(max. 3 participants)

*The course fee stated does not include overnight accommodation costs. These costs must be borne by the respective course participant. We will be happy to help you choose suitable accommodation.



Modern digital construction

Even complex work steps are easy to handle with the conceptCAD™ software.

The software runs quickly and reliably, even when processing complex cases, and provides an overview of all construction steps.

This allows system users to save time and optimize their daily throughput.

Our approach is to offer an open and modular CAD software in order to achieve maximum flexibility for all DCS users.

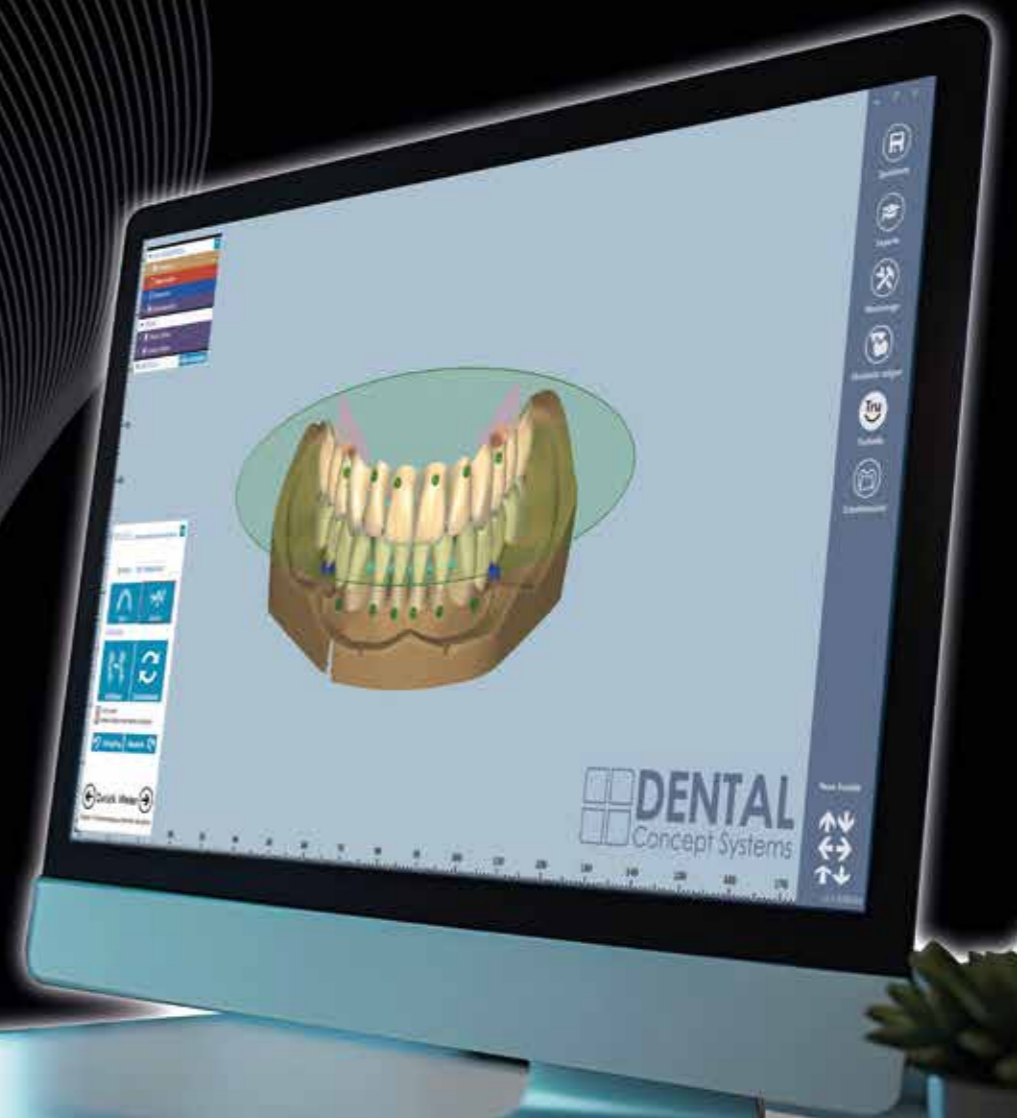

conceptCAD™ basic-training

In this one-day seminar you will learn how to use modern CAD software from scratch. Special PC skills are not required, ordinary basic knowledge is completely sufficient. We use simple case studies to show you the workflow as it is handled in practice. You will then be able to independently scan anatomical and reduced crowns and bridges and produce them ready for production.

Course content

- Structure of the ConceptCAD™
- Working with the order mask
- Design copings, anatomical crowns, bridges and splints
- Virtual articulator and other registration options
- Tips and Tricks
- Exchange of experience

Target group

conceptCAD™
and CAD/CAM beginners

Course details

Course duration: **1 day**
10:00 am to 6:00 pm
Course fee*: **€ 450,00 per participant**
(max. 6 participants)

* The course fee stated does not include overnight accommodation costs. These costs must be borne by the respective course participant. We will be happy to help you choose suitable accommodation.

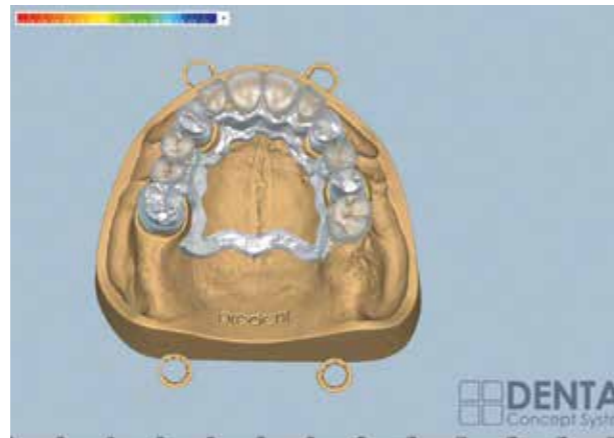
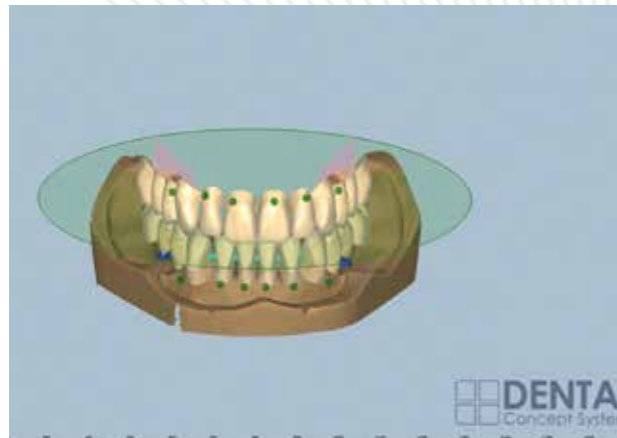

conceptCAD™ advanced-training

Experienced Exocad™ users will be introduced to the extended possibilities of the software in this one-day se-minar. Using complex case studies, they learn how to use expert mode safely. Other components are the design of individual abutments, bars and telescopic crowns, as well as the modeling of secondary structures (bar and telescope).

Course content

- Design of individual abutments, bars and telescopic crowns
- Modeling of secondary structures (bridge and telescope)
- Scan tactile and how we deal with the data
- Optimal fit parameters lead to optimal results
- Exchange of experience

Target group

Experienced conceptCAD™
or Exocad™ users

Course details

Course duration: **1 day**
10:00 am to 6:00 pm
Course fee*: **€ 550,00 per participant**
(max. 6 participants)

* The course fee stated does not include overnight accommodation costs. These costs must be borne by the respective course participant. We will be happy to help you choose suitable accommodation.

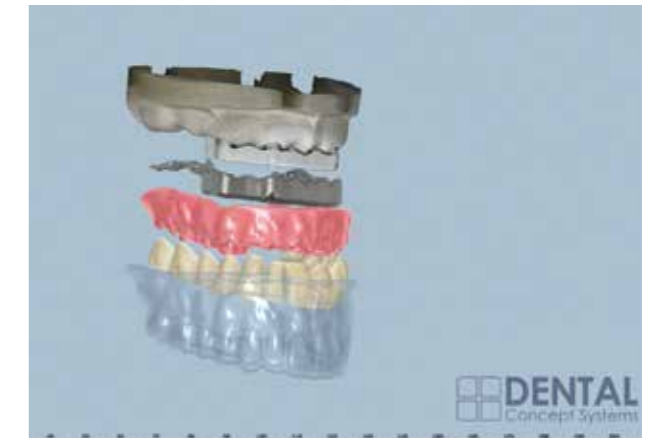
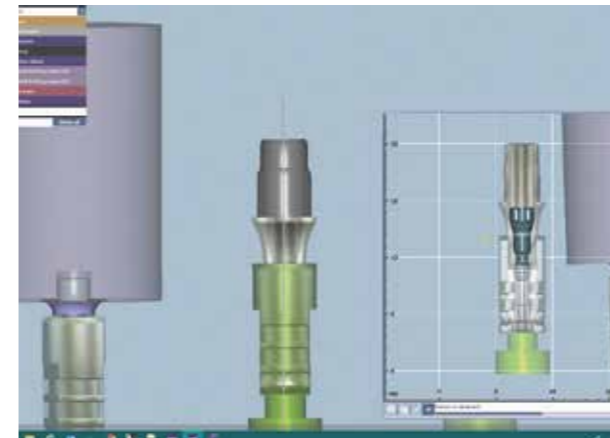

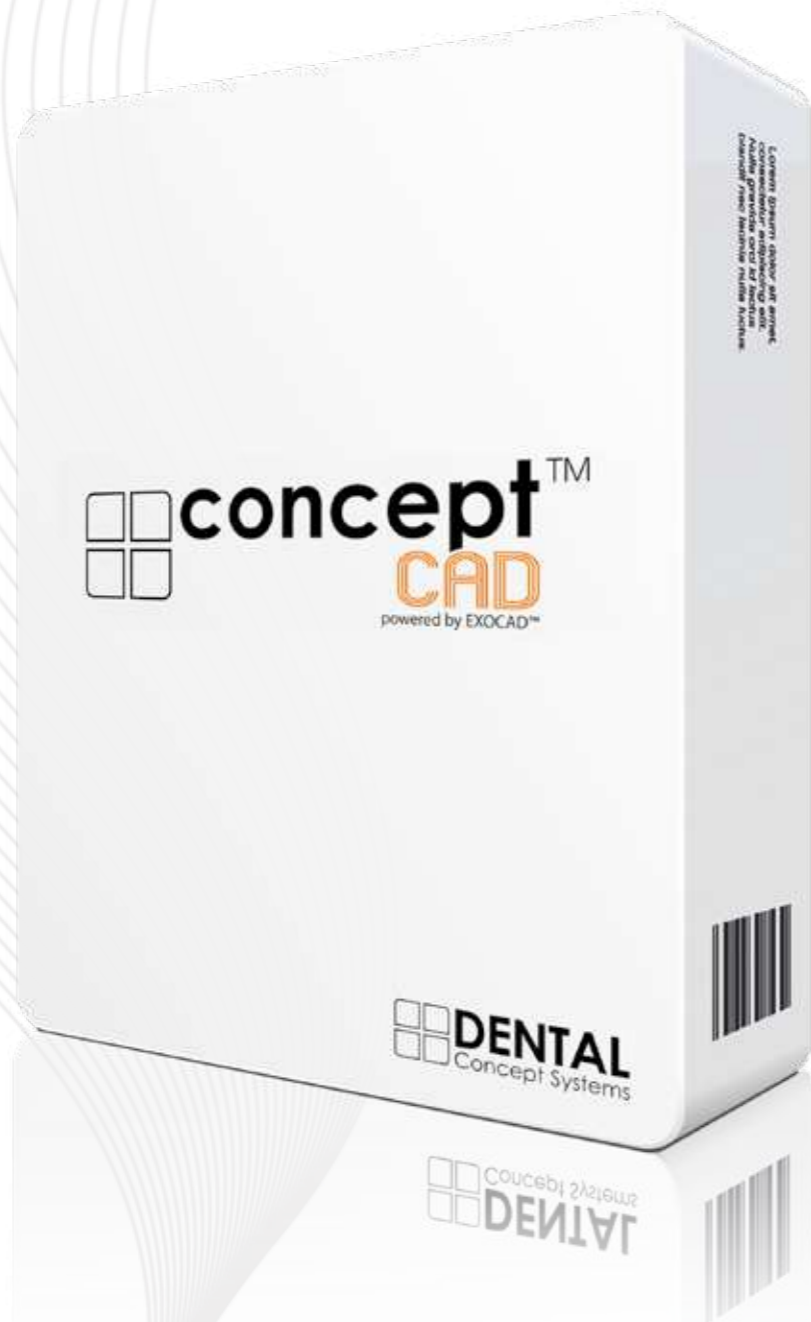

Experience new diversity... DCS training concept for expertCAM™ users

Do you want to get the best out of your DCS system, satisfy your customers and do it economically? Then you should use our - specially designed for the Dental Concept Systems machines -attend training courses. Here you will learn how to use the CAM software expertCAM™ and get useful tips and tricks to achieve your goals.

Experienced trainers guarantee a high level.

You will learn how to safely operate the powerful yet easy-to-use CAM software expertCAM™. This creates the basis for maximum efficiency and process reliability in your production.

This training series was developed in order to be able to respond to your requirements in the best possible way. The necessary user knowledge is trained in the one-day basic training. If you want to acquire advanced knowledge for extensive restorations, it will take another day expertCAM™ advanced training is offered.



expertCAM™ basic-training

Course content

General operation of expertCAM™

- How are one or more objects loaded?
- What edits can I make to the object?
- Align and place objects
- Creation of projects / blanks
- Generation of new blank geometries
- Settings for auxiliary elements (connectors, sinter frames/pins)

Practical use of expertCAM™

- Training for practical CAM application on the DCS system
- Routine application in connection with DC conceptCONTROL™ control software and conceptCAD™
- Practical application for the different functions of your laboratory team
- Familiarization with DCS support ticket & webinar system
- Training in a wide variety of expansion options in the expertCAM™

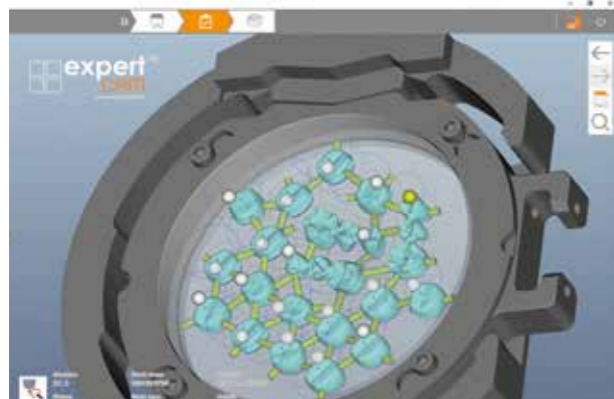

Target group

DCQ™, DCX™, DC1™ and DC3™ / DC7™ users with basic PC knowledge and little or no expertCAM™ knowledge

Course details

Course duration: **1 day**
9:00 am to 6:00 pm
Course fee: **€ 620,00 per participant**
(max. 8 participants)

* The course fee stated does not include overnight accommodation costs. These costs must be borne by the respective course participant. We will be happy to help you choose suitable accommodation.

OUR TIP!

Book the DCS course package with expertCAM™ basic-training and expertCAM™ advanced-training and take advantage of the benefits!

expertCAM™ advanced-training

Course content

Explanation of the advanced functions

- Preparation of complex restorations, e.g. superstructure on implant bars, telescopic work, drilling templates, model casting

Milling of implant-supported restorations

- How do I proceed when processing implant-supported objects?
- Possibility to adjust the fit

Processing of glass ceramics

- How are glass ceramic blocks processed and what do I have to watch out for?

Processing of preform abutments

- How are preform abutments processed?

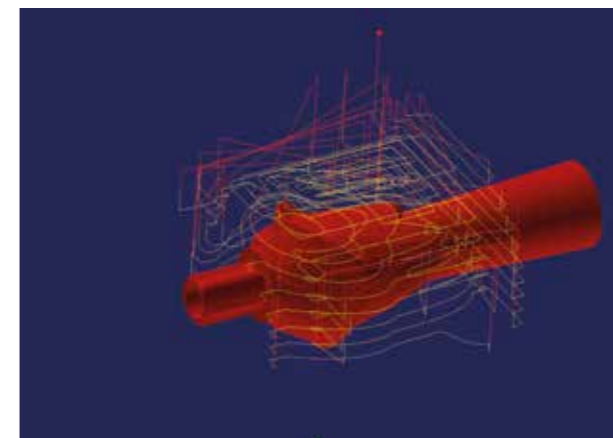
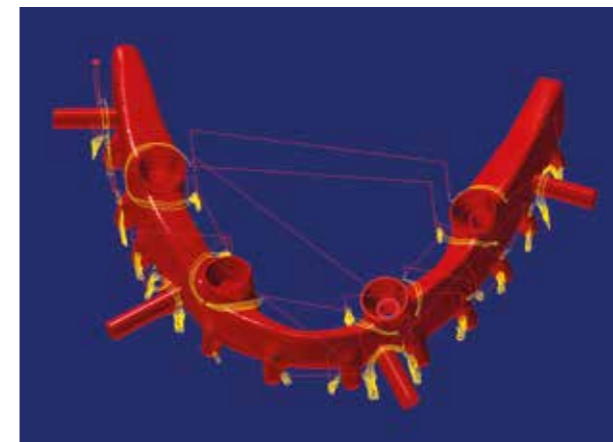

Target group

DCQ™, DCX™, DC1™ and DC3™ / DC7™ users as well as expertCAM™ users. Users should have completed the expertCAM™ basic training successfully or have practical experience with expertCAM™.

Course details

Course duration: **1 day**
9:00 am to 6:00 pm
Course fee: **€ 620,00 per participant**
(max. 8 participants)

* The course fee stated does not include overnight accommodation costs. These costs must be borne by the respective course participant. We will be happy to help you choose suitable accommodation.

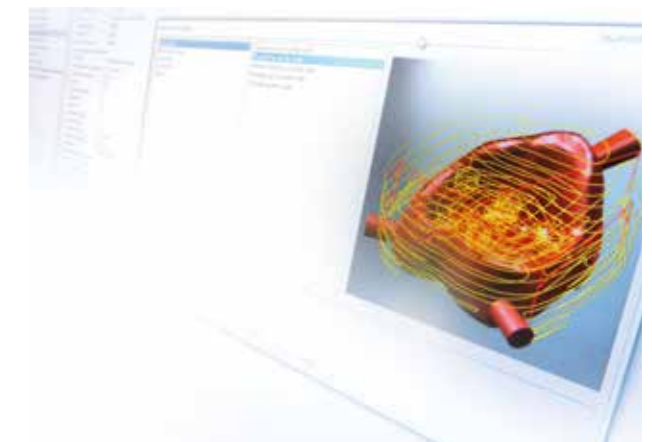

OUR TIP!

DCS course package!
expertCAM™ basic-training
+ expertCAM™ advanced-training

€ 1.000,00
per participant!



For those who want to go higher ...

- simple operation combined with the performance of an industrial CAM
- Optional implant module with integrated library with worldwide compatible implant connectors for milling on regular geometries
- Automatic residual material recognition with reliable collision check enables faster milling times with longer tool life
- Group-based milling keeps tool changes to a minimum even with different milling strategies

conceptCAM™ basic-training

Work with the utmost precision and efficiency right from the start and don't waste unnecessary time preparing your milling work. Learn the basics of professional and most reliable CAM software, conceptCAM™ and optimize your everyday life. The participants get a step-by-step introduction to the operation and use of conceptCAM™ based on simple dental indications and are prepared for the advanced training.

With the completion of the basic training, you will be able to safely and quickly prepare standard dental indications, such as crowns and bridges, in conceptCAM™ and manufacture them on your machine without unnecessary loss of time. In addition, during the course you will get an overview of the performance that only conceptCAM™ can offer you.

Course content

What is the CAM software?

- What do you need CAM software for and what does it do exactly?

How do I create a new project?

- Extensive explanation of project creation in conceptCAM™

What is the preparation mode?

- Explanation of the preparation mode
- Basic operation and structure of the GUI
- Introduction to the „steps“ of the preparation mode
- The calculation

Basic settings conceptCAM™

- RCreate and manage blanks
- Basic settings of conceptCAM™

Target group

Beginners in conceptCAM™ as well as CAD / CAM beginners

Requirements

Interest in DCS systems

Course details

Course duration: **1 day**
10:00 am to 6:00 pm
Course fee*: **€ 620,00 per participant**
(max. 8 participants)

*The course fee stated does not include overnight accommodation costs. These costs must be borne by the respective course participant. We will be happy to help you choose suitable accommodation.



conceptCAM™ advanced-training

The right software is only one side of the coin. The correct use of the software is equally important. Therefore this course provides you with all the knowledge you need to be able to confidently use the software, from open questions on the principles of conceptCAM™ to complex tasks.

During the course, participants are placed in a practical setting, working directly with conceptCAM™ themselves and gain a much deeper understanding of the software. This course imparts the ability to skilfully master all tasks with maximum precision, maximum process reliability and the shortest production times. This know-how will delight not only you, but also your customers.

Course content

What is the residual material step and what can I use it for?

- Detailed explanations of processing steps
- Practical examples of usage (models, attachments, telescopes, etc.)

What is drill hole recognition for?

- Practical examples for the programming of abutments / implant bridges on adhesive bases
- Introduction to the processing of drilling templates

How does one mill medentika® prefabricated? What needs to be observed?

- Instruction on the pre-form processing of conceptCAM™

How do I use machine simulation?

- Explanation of the conceptCAM™ machine simulation
- Creation and analysis of cutting mode

How can I benefit from the integrated "Native CAD interfaces"?

- Explanation of the interfaces for importing "native CAD data" (e.g. dcm, cercon or cerec)

How are special indications programmed correctly?

- Practical examples of the milling of models
- Practical examples of the processing of occlusal splints
- Practical examples of the manufacture of a model casting

What else is there to discover in conceptCAM™?

- We show you further very useful tools integrated in conceptCAM™

Target group

Advanced DCQ™ / DCX™ / DC1™ and DC3™ / DC7™ users

Requirements

CAM basic DCQ™ / DCX™ / DC1™ / DC3™ / DC7™ or conceptCAM™ basic training

Course details

Course duration: **1 day**
10:00 am to 6:00 pm
Course fee*: **€ 620,00 per participant**
(max. 8 participants)

*The course fee stated does not include overnight accommodation costs. These costs must be borne by the respective course participant. We will be happy to help you choose suitable accommodation.

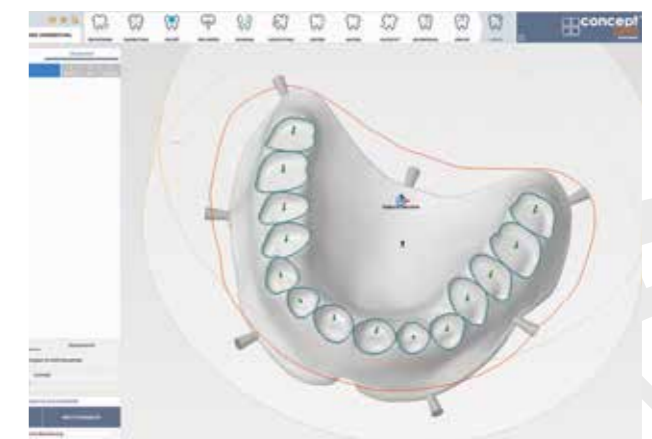

conceptCAM™ implant-training

Become a professional in the processing of implant-borne indications and manufacture them easily with unique precision and the highest quality.

The course explains to the participants all important steps for the production of implant-supported dentures in conceptCAM™. The functionalities of the implant module are explained to you step by step and you will apply them yourself using practical examples. Furthermore, the participants in milling tests are given a feeling for controlling and adjusting the fit of the milled parts.

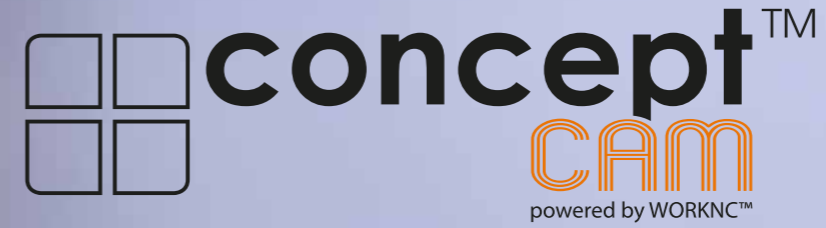

Course content

Which possibilities does the implant module offer?

- Explanation of the "implant" programming step
- Real-life example of using the implant steps
- Functions of the implant module

How do you adjust the fits yourself?

- Introduction to the "Implant Library"
- Fit adjustment functions
- Milling test for clarification and sensitization
- Adjusting the library to CAD data / scanbodies

What peculiarities there when editing?

- Tips and tricks for safe and correct processing of implant connections

Create metadata yourself

- Introduction to the "Implant Position Editor"

Target group

Advanced DCQ™ / DCX™ / DC1™
and DC3™ / DC7™ users

Requirements

CAM basic DCQ™ / DCX™ / DC1™ / DC3™ / DC7™
or conceptCAM™ basic training

Course details

Course duration: **1 day**
10:00 am to 6:00 pm
Course fee*: **€ 620,00 per participant**
(max. 8 participants)

* The course fee stated does not include overnight accommodation costs. These costs must be borne by the respective course participant. We will be happy to help you choose suitable accommodation.

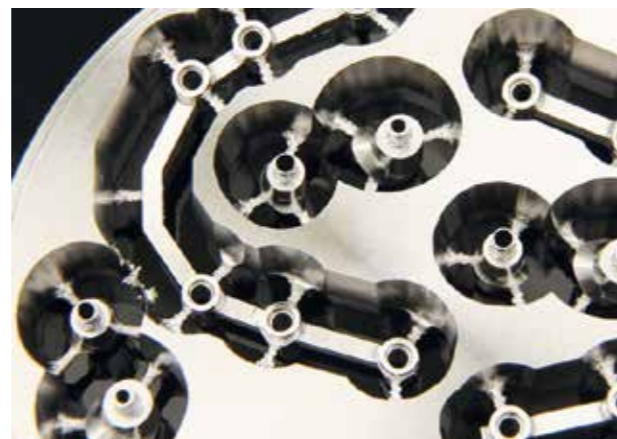
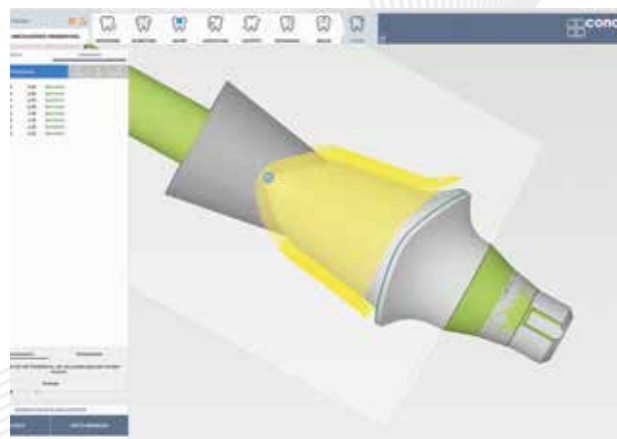

Eisenhammer IMPRESSIONS

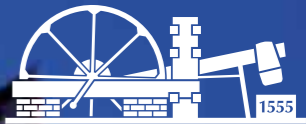

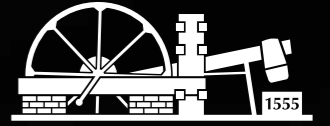

DCS-TEAMEVENTS

Expertise meets team spirit
- your unforgettable event in the Wesertal!

Experience unforgettable team events in the idyllic Wesertal
- Works perfectly with dental laboratories and their employees!

Growing together, learning new things and coming together as a team
- that's exactly what DCS's tailor-made team events offer!

In the beautiful Wesertal valley, we combine practical dental technology courses
with exciting leisure activities and sociable evening programs.

Your individual event – everything from a single source:

- Professional training in dental technology
- Team building & motivation through shared experiences
- Activities such as e-bike tours, climbing, boat trips & more
- Evening events with pizza baking in the in-house oven, cooking courses and much more.
- Fully organized – including hotel booking & supporting program

Regardless of whether you want to motivate your employees, strengthen team cohesion or simply experience an extraordinary time - we develop your individual multi-day team event exactly according to your wishes.

Enquire now & strengthen team spirit!

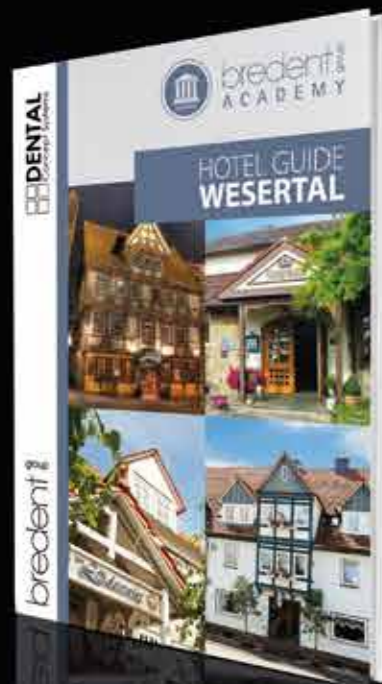

USE OUR HOTEL GUIDE

In our **HOTEL GUIDE** we have compiled
hotel recommendations for you and your employees.

After a successful TEAM EVENT, you will find guaranteed
relaxation here. We will be happy to make the reservation
so that you don't have to worry about anything.

The **HOTEL GUIDE** can be found online at
www.dental-concept-systems.com





 **DENTAL**
Concept Systems

Dental Concept Systems GmbH
Gieselwerder Str. 2
D - 34399 Wesertal

Telephone: + 49 (0) 5572 3021010
Fax: + 49 (0) 5572 3021099
www.dental-concept-systems.com

a company of
bredent group

